

Composite dry sliding bushings, metric dimensions

Principal dimensions			Basic load ratings		Mass	Designation
d	D	B	dynamic C	static C0		
mm			kN		kg	-
30	34	30	69,5	220	0,045	PCM 303430 E

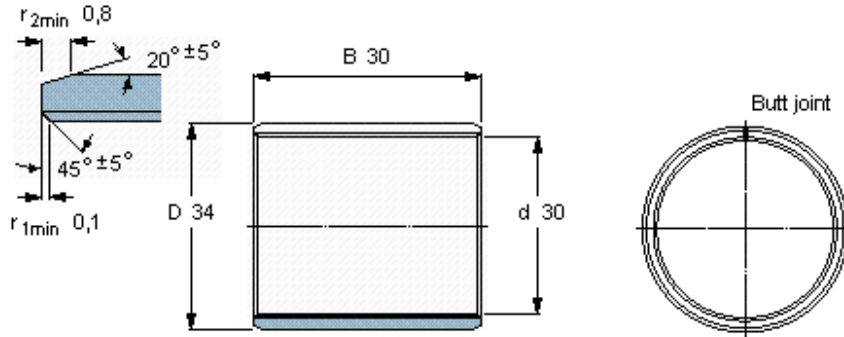

Specific load factor
Material constant

K 80
K_M 480